

YDEA-MDEA(MDEA2PLUS) User Manual

Version: 2-0-5

Statement Respectable

Users:

Welcome to use products of YDEA! We are appreciated if our user manual offers help and convenience to you when you are using or learning about our products. In order to pursue accuracy and reliability, our company will modify or change the content of the manual at any time without notification. Should you have any question or good suggestion, please contact us with the information in the manual. We will spare no effort to solve your issue. Simultaneously, after assessment we will adopt your suggestion with many thanks!

The copyright of this manual shall be owned by YDEA Technology Co.,Ltd. Any individual or unit without written permission shall not copy or extract the content of the text in any form.

<http://www.ydeachn.com/>







Address: Skyworth innovation valley 5# A layer ,901 Tangtou Road no. 1 on the 8th Shiyan Street
Baoan District Shenzhen City .

Catalogue

1	Security statement	3
2	Outline	3
3	Technology specification	5
4	Interface introduction	
	MDEA2PLUS interface introduction	7
5	Signal of system connection diagram	
	C5C_Mdea system hardware connection diagram	9
	C5M_Mdeasystemhardwareconnectiondiagram	10
6	MDEA system software operation	
	MDEA software basic operation introduction	11
	MDEA system software operation	12
	C5C_Mdea system software test	21
	C5M_Mdea system software test	25
7	MDEA2PLUS system Q&A introduction	33
8	MDEA2PLUS system installation size	33

Security statement

In order to avoid danger, please use this device according to stipulation. If damage occurred, please do not repair it without professional person and contact after-sales service personnel of YDEA.

	<p>High voltage danger: working voltage is 5V DC</p>
	<p>Ground connection: the ground wire of power is connected to the ground. Make sure the conductor connecting to the ground is working well.</p>
	<p>Electromagnetic interference: device shall be away from Magnet, motor and transformer.</p>
	<p>Dam proof: device shall be stored in dry, clean circumstance. Please pull the plug once it has liquid immersion.</p>
	<p>Be away from inflammable and explosive goods</p>
	<p>In order to avoid security incident, please prohibit liquid, mental fragment from going into device.</p>

Outline

MDEA2PLUS is an integrated and creative LED system for advertisement player with lower cost from YDEA, which is applied to advertisement issue and building lighting display.

MDEA2PLUS is an integrated system with network issue system, single play system, and LED system control. It has WIFI, and circumscribed 3G. Send message by network and have video synchronized broadcast. It's designed with media player function, and you can use it as the PC to achieve a single device play. Having the built-in video processing and LED controller, makes it compatible with LED synchronous and asynchronous systems of competitive price. With this system, we can help customers simplify the system structure and reduce costs.

It helps to solve the service problems such as complex structure, more external devices, single function, high cost, difficult system management.

<http://www.ydeachn.com/>

Address: Skyworth innovation valley 5# A layer ,901 Tangtou Road no. 1 on the 8th Shiyan Street
Baoan District Shenzhen City .

Product characteristics

1. Having the built-in video processing and LED controller, makes it compatible with LED synchronous and asynchronous systems.
2. MDEA2PLUS system adopts new structure to realize quick opening the screen, which greatly shorten the time of engineers.
3. Support wireless network communications, and wireless communication between the computer and Mdea.
4. Replace Screen without resetting, with features of easy maintenance, convenient and fast.
5. MDEA2PLUS is an integrated LED media play device with network distribution system, LED control system, single-play system achieving a high degree of integration structure;
6. MDEA2PLUS comes with media play function, you can use it as the PC to achieve a single device play; integrated hardware decoding module can support 720P HD video decoding and playback; content can be stored in the U disk and then play.

Technology specification

Hardware Configuration		
CPU	Cortex-A7	
GPU	Mali400, Speed 400MHz	
RAM	DDR3 1GB	
ROM Flash	8GB	
Multi-media	Photo Viewer	BMP, JPEG, M-JPEG, GIF, PNG
	Video Format	MEPG1/2/4,H.263/H.264,RMVB,WMV/VC-1,MVC,AVS, MJPEG.
	Audio Format	MP3,WMA,WAV,OGG,FLAC,ALAC,APE,AMR,AAC,AC-3
Interface Configuration		
HDMI	1 x HDMI1.3 Output(1280*720/60hz)	
WIFI	802.11b/g/n	
Audio	1 x 3.5mm,	
USB	1 x USB, Support OTG、 HOST and DEVICE,1*USB-A (Support a mouse, keyboard, 3G network card)	
LED Video	1x RJ45, Support 1024*600*24bit*60Hz	
Software Configuration		

<http://www.ydeachn.com/>

Address:Skyworth innovation valley 5# A layer ,901 Tangtou Road no. 1 on the 8th Shiyan Street
Baoan District Shenzhen City .

Operating system	Andriod 4.2.2
Control Software	YdeaFast V2.0.5.12
Player software	Player software system
Electrical Specifications	
Power	Switching Power Supply (5V、 3A)
Temperature	-40°C ~ 75°C
Consumption	$\leq 15W$
Size (L× W)	120 mm × 68.5 mm

Interface introduction

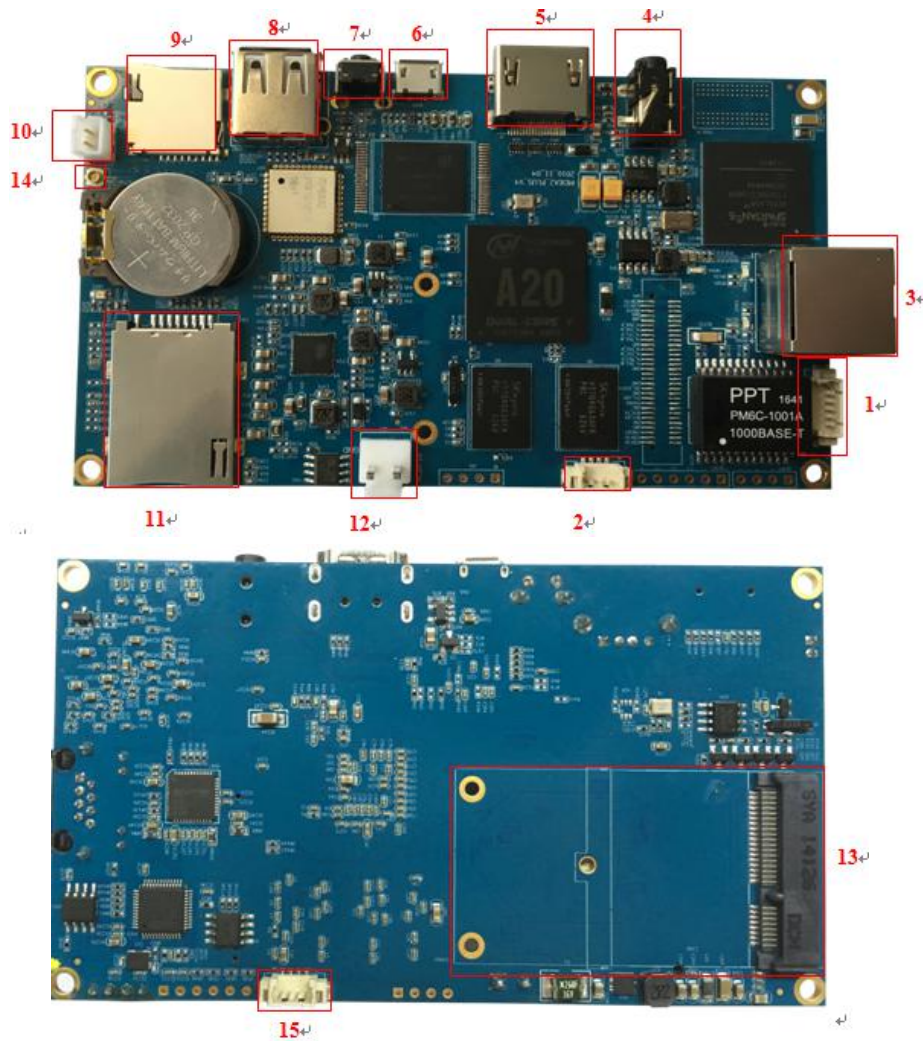

Number	Functions	Note
1	Brightness sensor interface	Brightness sensor interface
2	Serial port7	Set aside a serial port interface
3	LED system output	Used for LED output signal
4	3.5mmaudio connect	connect headphones and speakers
5	HDMI connect	interface HDMI display, used for debugging
6	Micro USB	Burning system firmware
7	Key	Used for wifi reset and system recovery work

<http://www.ydeachn.com/>

Address:Skyworth innovation valley 5# A layer ,901 Tangtou Road no. 1 on the 8th Shiyan Street
Baoan District Shenzhen City .

8	USB	Can meet U disk, mouse, keyboard
9	SDboot	Used to expand storage capacity
10	2PIN connect	Sub to burn system firmware
11	SIM connect	Unicom mobile 4Gcard and card interface
12	DC input	DC5V/3A
13	PCIE connect	4G module interface
14	antenna interface	Wifi antenna interface
15	Serial port1	Set aside a serial port interface

Interface introduction

Power interface: Mdea system support power input DC5V ;

Micro USB: refresh Mdea system hardware;

USB: support USB input. For example, U disk, mouse and keyboard;

HDMI output: support circumscribed HDMI/DVI interface display to monitor Mdea system operating status;

Audio output: support 3.5 audio interface;

LED video output interface: use to connect Mdea and receiving card, sending video signal with standard T568B network wire;

Refurbishment button: use to connect computer and Mdea, refreshing hardware version of the Android in the Mdea;

<http://www.ydeachn.com/>

Address: Skyworth innovation valley 5# A layer ,901 Tangtou Road no. 1 on the 8th Shiyan Street Baoan District Shenzhen City .

System, hotspot restore button: use to restore android system and WIFI hotspot;

Remarks: functions of System, hotspot restore button;

System Restore is mainly used in abnormal playback software, or system software failure. Use the restore factory settings, all software can be restored to the factory default state.

Steps to restore: Press the button, connect power, and wait for 7 seconds, release the button go into recovery mode;

Hotspot restore : Press for 2s, the device can be switched to the hot state;

Remarks: 1.Keep pressing for 7s as soon as it connected to electricity to restore system; when the system is running normally, press for 2s restored to the hotspot.

2.Waiting for 30s, the device will be restarted. If failed, please restore or upgrade the hardware.

System signal connection diagram

1. hardware connection diagram of MDEA general system C5C_Mdea

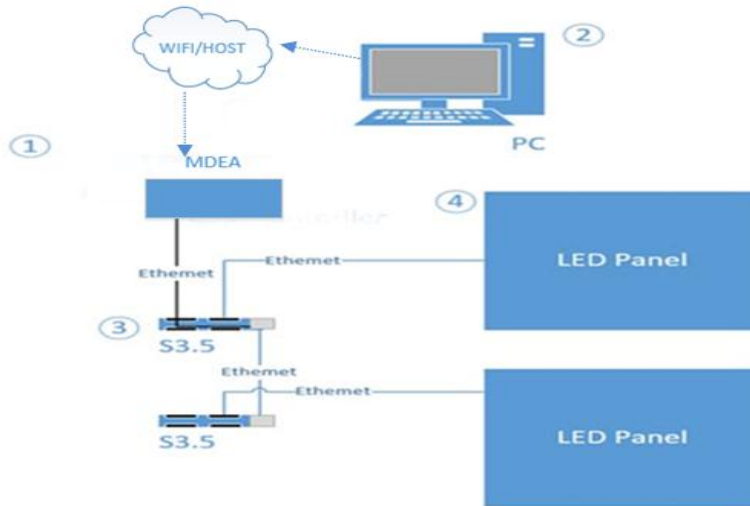

System statement:

- 1) Three receiving card can directly connect screen. The card used below is S3.5. For S3.0 and S3.1, hardware connection needs to change into a corresponding receiving card;
- 2) For different receiving cards, except that the procedures are different, the rest operations are the same.
- 3) The ports of receiving card don't divide into input or output, thus using any normal network wire connected to the port of the controller could make it work.
- 4) Use one port of the receiving card to cascading to another receiving card.
- 5) Computer via WIFI or hotspot of Mdea to realize debugging display

<http://www.ydeachn.com/>

Address: Skyworth innovation valley 5# A layer ,901 Tangtou Road no. 1 on the 8th Shiyan Street
Baoan District Shenzhen City .

without network.(Mdea hotspot is produced from the system itself.)

2. MDEA Micro C5M_Mdea hardware connection diagram

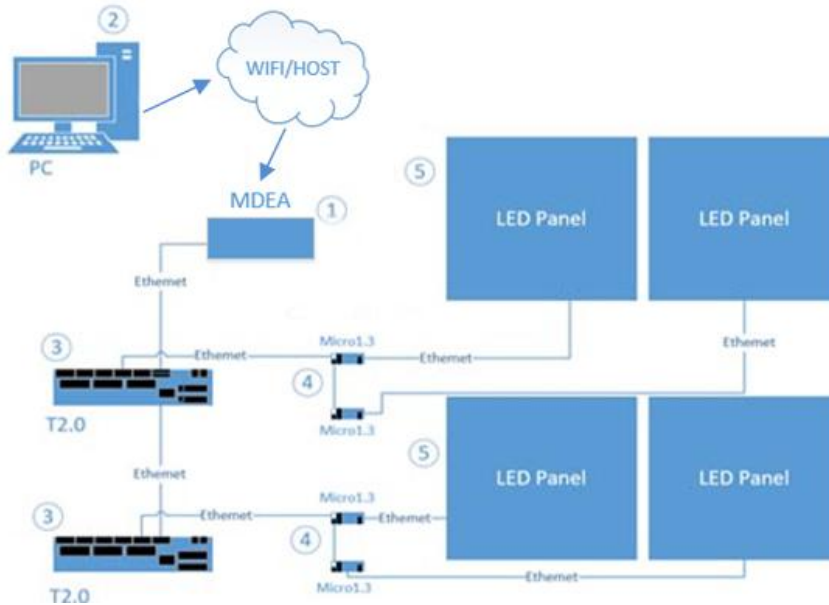

System statement:

1. Take Micro1.3 for example. Different Micro receiving card are with different procedures, but the rest operations are the same.
2. Output port of Mdea connects to In port of T2.0 by standard network cable. Link port is used to cascading several distributors.
3. There are input and output ports in the receiving card. "In" means input and "Out" means output. All 8 ports of T2.0 can output signal.
4. Use out port of receiving card cascading to in port of next card. ;
5. Computer via WIFI or hotspot of Mdea to realize debugging display without network.(MDEA hotspot is produced from the system itself.)

<http://www.ydeachn.com/>

Address:Skyworth innovation valley 5# A layer ,901 Tangtou Road no. 1 on the 8th Shiyan Street
Baoan District Shenzhen City .

MDEA system software operation

1. MDEA Software basic operation introduction

double click icon to enter control software



system switch

Click [setting]--- [version switch]—

switchtoC5C/C5C_Mdea/C5M/C5M_Mdea version

Remark :

1. C5C/C5M means the current debugging software is of C5 system. C5C_Mdea/C5M_Mdea means the current debugging software is of MDEA2PLUS system. Choose the system you need. Every time you select the system, the software will restart. Meantime, at the top left corner of software should display the current system, which is showed as below:

<http://www.ydeachn.com/>

Address: Skyworth innovation valley 5# A layer ,901 Tangtou Road no. 1 on the 8th Shiyan Street
Baoan District Shenzhen City .

2. MDEA system selects C5C_Mdea or C5M_Mdea ;

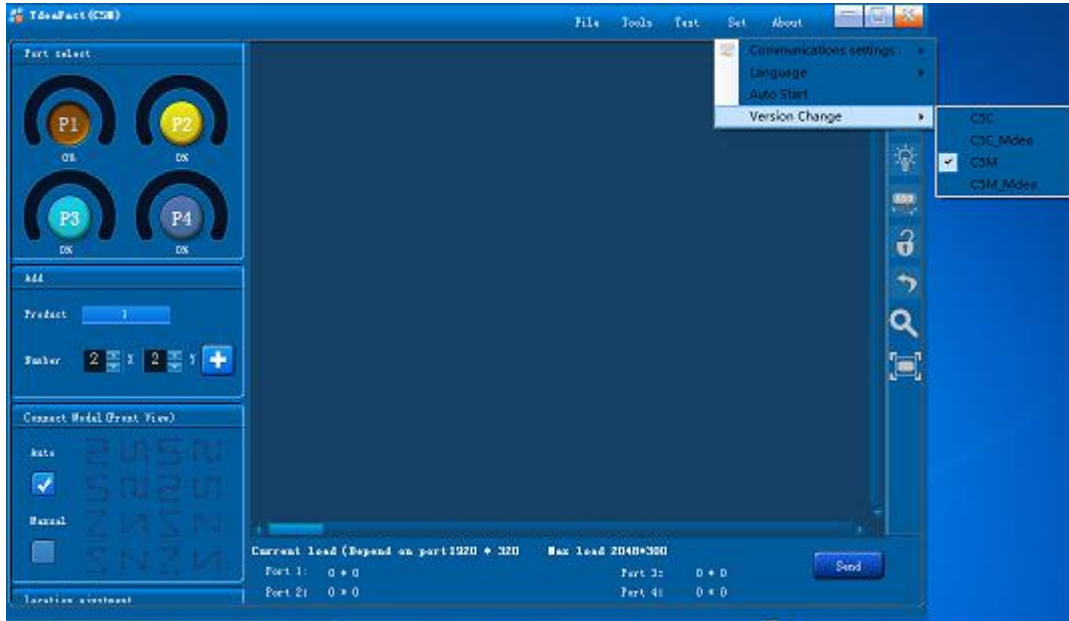

(Picture 1 software interface)

Main interface introduction



(Picture2 software interface)

<http://www.ydeachn.com/>

Address: Skyworth innovation valley 5# A layer ,901 Tangtou Road no. 1 on the 8th Shiyan Street Baoan District Shenzhen City .

Shown as the picture, there are 4 areas in the main interface, which are function area, operation area, menu area and shortcut menu area.

2. Basic operation introduction

1.1 Test the port connection:

Software switches to Ethernet port communication (computer connects to hotspot), then internet of computer connect to hotspot of Mdea;

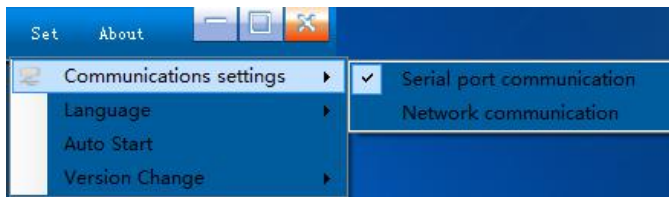

(Picture 3 Connect set)



(Picture 4 Ethernet port connection)

Remark :

1. MDEA2PLUS system can produce Hotspot by WIFI, or connect to the outside Ethernet;

2. The differences between Mdea and C5 system is that Mdea system can't via serial port to connect computer; so computer can via WIFI or hotspot to connect MDEA2PLUS system to realize controlling network.

3. MDEA2PLUS system with the hotspot, can product hotspot with the name of “_host”;

<http://www.ydeachn.com/>

Address: Skyworth innovation valley 5# A layer ,901 Tangtou Road no. 1 on the 8th Shiyan Street
Baoan District Shenzhen City .

Click the refresh button to see whether connect to Mdea hotspot successfully.

Show as below.

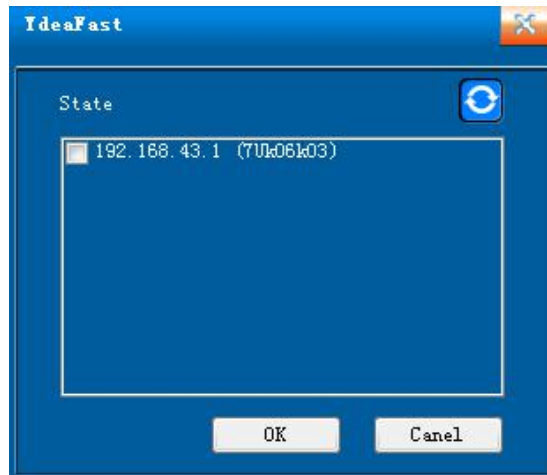

Connect successfully;



(Picture5 means connect successfully)

When connected successfully, there is IP address appeared. When arrow points to the box, check the IP and then click confirm. In this way, the software is connected to MDEA.

<http://www.ydeachn.com/>

Address: Skyworth innovation valley 5# A layer ,901 Tangtou Road no. 1 on the 8th Shiyan Street
Baoan District Shenzhen City .

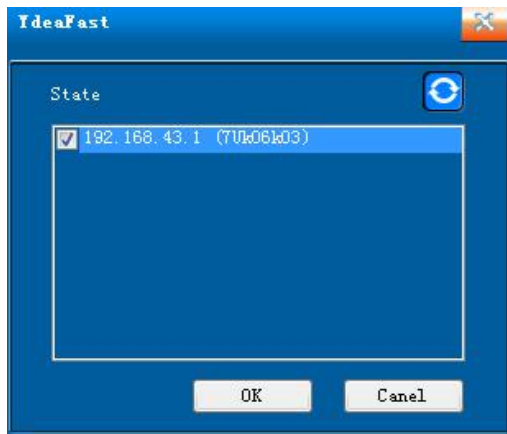

(Picture6 Ethernet port communication)

If software is connected abnormally or fail to connect, you need to reconnect.

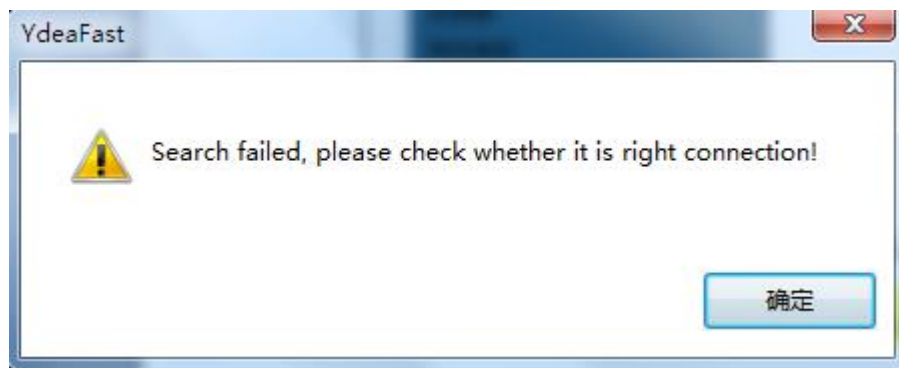

Remark : 1. If fail to connect, try to refresh for several times. If failed again, restart to connect.

2. Make sure Mdea system hotspot is normal.

1.2 Menu introduction

1.Files

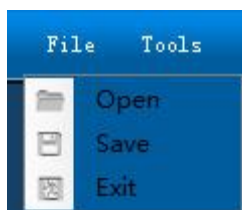

(Picture7 files)

<http://www.ydeachn.com/>

Address: Skyworth innovation valley 5# A layer ,901 Tangtou Road no. 1 on the 8th Shiyan Street
Baoan District Shenzhen City .

Open: open the screen connection parameter files.

Save: can save the current parameter as a configuration file for future uploading;

Exit: click to exit the software.

2.Function

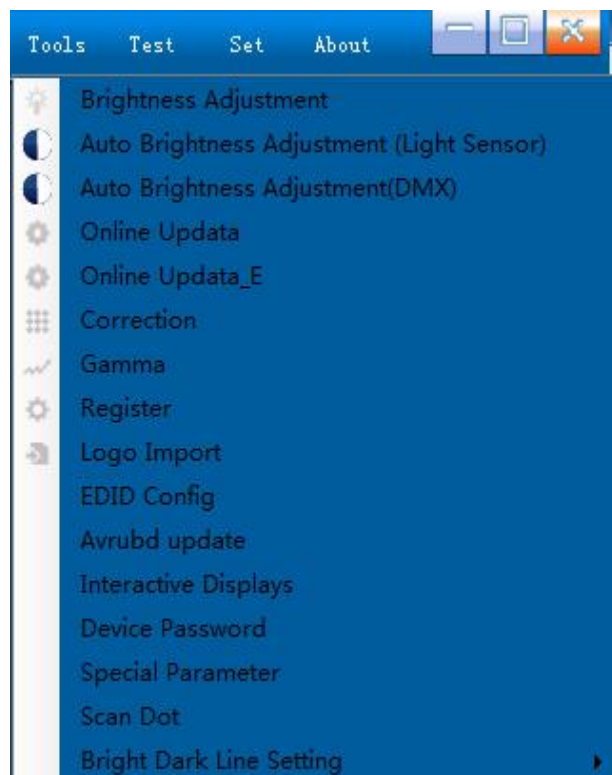

(Picture 8 function)

Brightness: adjust the whole brightness, current gain, color temperature

<http://www.ydeachn.com/>

Address: Skyworth innovation valley 5# A layer ,901 Tangtou Road no. 1 on the 8th Shiyan Street
Baoan District Shenzhen City .

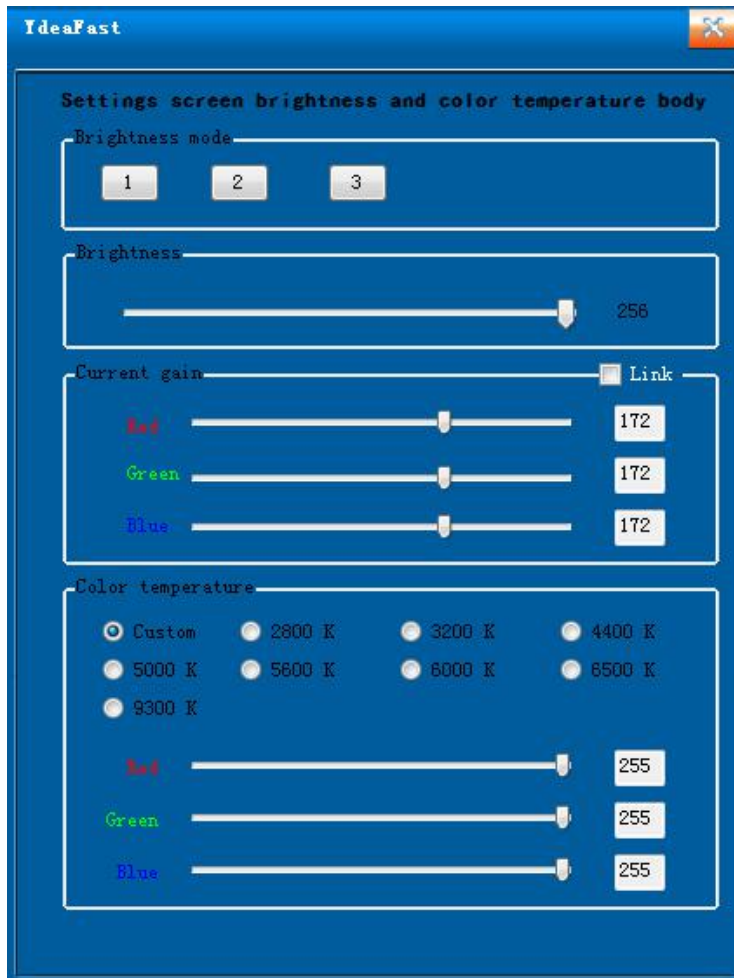

(Picture9 brightness)

Brightness range: 1-256

Current gain range : 1-256

Single color temperature range: 0-255

Remark:Change the color temperature range of red, green and blue to adjust color temperature coordinate.

Light Sensor : Mdea does not support this function now.

Automatic brightness adjustment _DMX : refer to "Mdea brightness automatic_DMX user manual";

<http://www.ydeachn.com/>

Address:Skyworth innovation valley 5# A layer ,901 Tangtou Road no. 1 on the 8th Shiyan Street
Baoan District Shenzhen City .

Upgrade online: input password 86586287. Enter upgrade interface to select the hardware. Import BIN file and click upgrade.

Remarks: in the Mdea system, it can upgrade Mdea system by using computer via WIFI or hospot.

Upgrade online_E version: it needs latest upgrade procedures. Please ask technician for details.

Spot-spot correction: Mdea does not support now.

Gamma: can adjust different grey level.

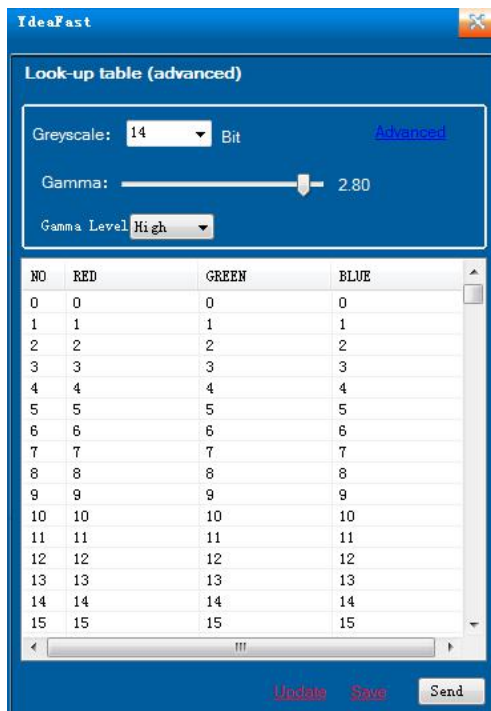

(Picture10 Gamma setting)

Grey level range: 8-16Bit ;

Gamma transition value range: 0.000-3.00 , use to adjust gradient of gamma curve.

<http://www.ydeachn.com/>

Address: Skyworth innovation valley 5# A layer ,901 Tangtou Road no. 1 on the 8th Shiyan Street Baoan District Shenzhen City .

Gamma level: has high, medium and low levels, which can realize high grey and low brightness.

Update, save, send: update to be the Gamma diagram of the current setting parameter. Save means to save the current Gamma diagram in the software, which helps to uploading when open this window next time.

Finally, send the current parameter to the controller.

Register setting: can set the value of register.

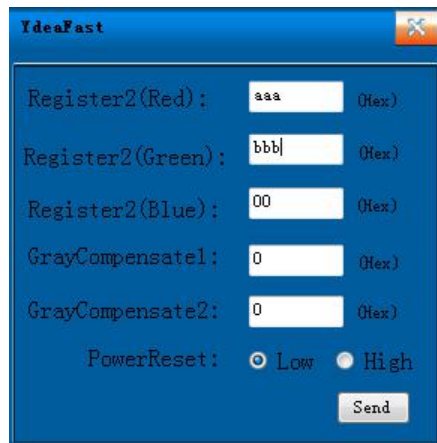

(Picture 11 register setting)

Logo input: import LOGO to the little LCD at the back of the display.

EDID configuration: Mdea system does not support this function because of without DVI signal input.

Characteristic parameter: adjust red, green, and blue sequence (used on dot lighting)

Mapping tool: used on dot lighting mapping. Mdea does not support this setting now.

<http://www.ydeachn.com/>

Address: Skyworth innovation valley 5# A layer ,901 Tangtou Road no. 1 on the 8th Shiyan Street
Baoan District Shenzhen City .

1.3 Setting

Communication setting: Ethernet port communication or serial port communication.

Remarks:

- 1.serial port communication is used on computer and C5 system. Via serial port, computer connects to C5.**
- 2. Ethernet port communication: used in the communication between computer and MDEA. Computer and MDEA are in the same LAN.**

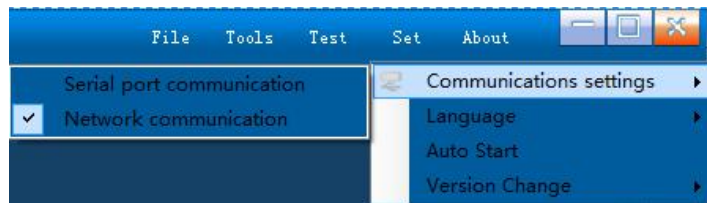

(Picture 12 communication setting)

Language: Chinese and English

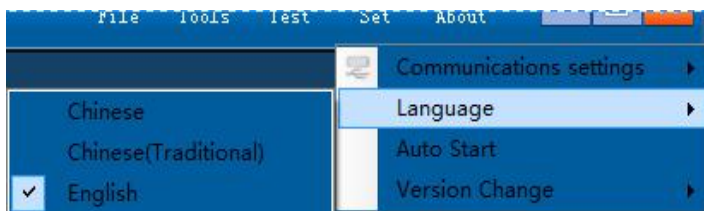

(Picture 13 Language)

Power on: set to be power on or not.

1.4 About

<http://www.ydeachn.com/>

Address: Skyworth innovation valley 5# A layer ,901 Tangtou Road no. 1 on the 8th Shiyan Street
Baoan District Shenzhen City .

Click the menu to check the version of the software, which is convenient for the communication between manufacturer and technicians.

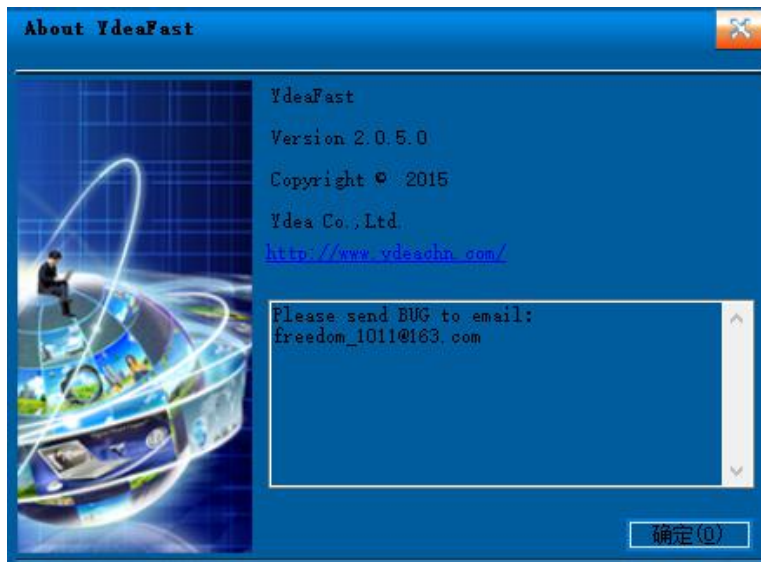

(Picture 14 14 software version)

2. Shortcut menu

<http://www.ydeachn.com/>

Address: Skyworth innovation valley 5# A layer ,901 Tangtou Road no. 1 on the 8th Shiyan Street
Baoan District Shenzhen City .



(Picture 15 shortcut menu)

Several shortcut menu buttons at the right of the main interface have functions as below:



: Open screen connections configuration files saved before.



: Save the current screen connections parameters as a configuration file, which is convenient for uploading next time.



: Click this button to adjust brightness, current gain and color temperature.

<http://www.ydeachn.com/>

Address: Skyworth innovation valley 5# A layer ,901 Tangtou Road no. 1 on the 8th Shiyan Street
Baoan District Shenzhen City .

Remark:

- 1.In the default status, value of current gain is hidden, which need password of ydea to show it.,the password is “ydea”**
- 2. Get the max current gain value of 172 when input the password of 0000.**



: Used to do serial port test.



: Click this icon to open and close display. If all of parameters are right but screen is black, click this icon to test whether the screen is on the status of close.

Remarks: 1. This shortcut button is the signal of opening and closing the display.



: When connect the wires manually or automatically, click this icon to cancel connection.



: Check the control system version of the current connected computer.

Remarks: this button could check the current system version, including controller version and receiving card version.



: When using “CTRL+MOUSE ROLLING” to enlarge the window, click

<http://www.ydeachn.com/>

Address: Skyworth innovation valley 5# A layer ,901 Tangtou Road no. 1 on the 8th Shiyan Street
Baoan District Shenzhen City .

this icon to go back to original window.

C5C_Mdea system software operation

1. Screen connection

1.1 Main controller port selection



<http://www.ydeachn.com/>

Address: Skyworth innovation valley 5# A layer ,901 Tangtou Road no. 1 on the 8th Shiyan Street
Baoan District Shenzhen City .

(picture 16 main control port)

Remark:

1.Mdea system supports single port output. Set P1 in the software.

The max pixel is 1024*600.

2.The default port is P1,do not choose.

1.2 Cabinet adding:

Click the button at right to enter sub-interface.

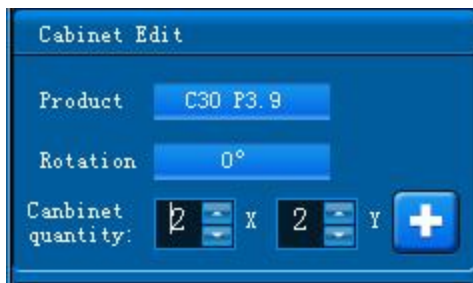

(Picture17 cabinet adding)

Product adding

Name: fill in content according to requirement. Set parameter for future division.

Width: pixels of width in the cabinet.

Height: pixels of height in the cabinet.

Adding: after setting parameter click adding, the product type list at right side will be saved automatically.

<http://www.ydeachn.com/>

Address:Skyworth innovation valley 5# A layer ,901 Tangtou Road no. 1 on the 8th Shiyan Street
Baoan District Shenzhen City .

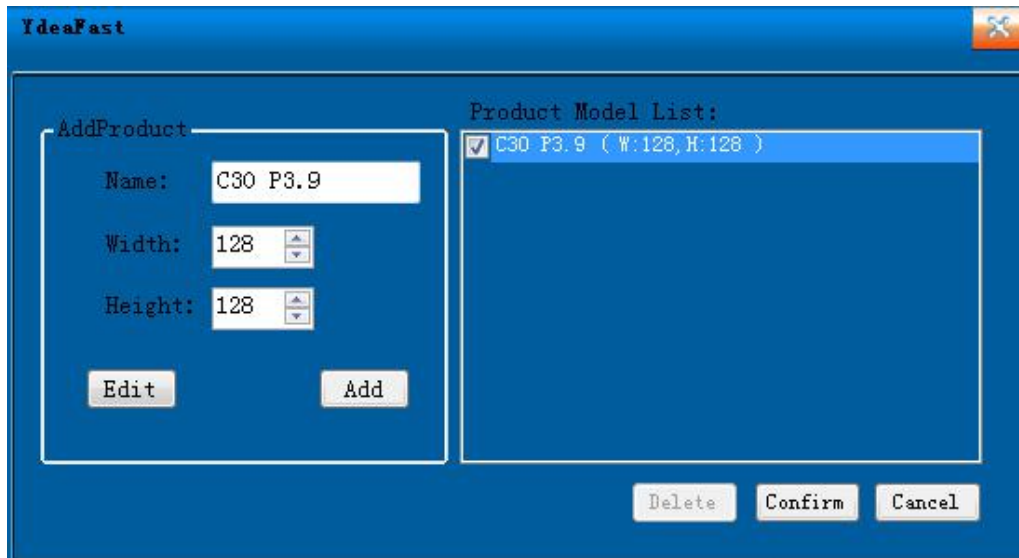

(Picture18 product adding)

Product list

Tick to select the product with presetting parameter. Then click confirm. Click "delete" to clear the information you don't want.

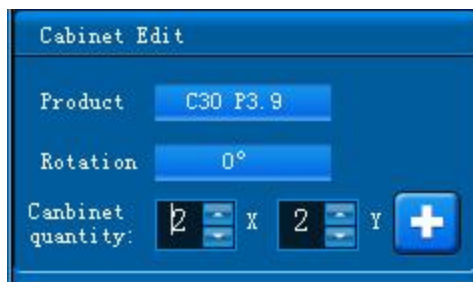

(Picture19 Add Product)

Rotation feature: 0°,90°,180°,270°

Cabinet quantity: X represent quantity of horizontal direction, and Y represents quantity of vertical direction. Users can add windows, which can be placed randomly to realize regular and irregular display. Show as below:

<http://www.ydeachn.com/>

Address: Skyworth innovation valley 5# A layer ,901 Tangtou Road no. 1 on the 8th Shiyan Street
Baoan District Shenzhen City .



(Picture 20 window setting)

2.1 Connection mode(facing screen):



(Picture 21 connection mode)

Wire connection mode means the wire take-up way at the back of the screen. There are manual and automatic selection. When choosing automatic one, there are 8 ways to be selected; when choose manual one,

<http://www.ydeachn.com/>

Address: Skyworth innovation valley 5# A layer ,901 Tangtou Road no. 1 on the 8th Shiyan Street
Baoan District Shenzhen City .

you can click left mouse button to arrange the cable, which can realize the irregular wire arrangement. Any place without wire has to keep vacant.

3.1 Position accurate adjustment

Input X and Y position to modify the initial position of the window accurately;

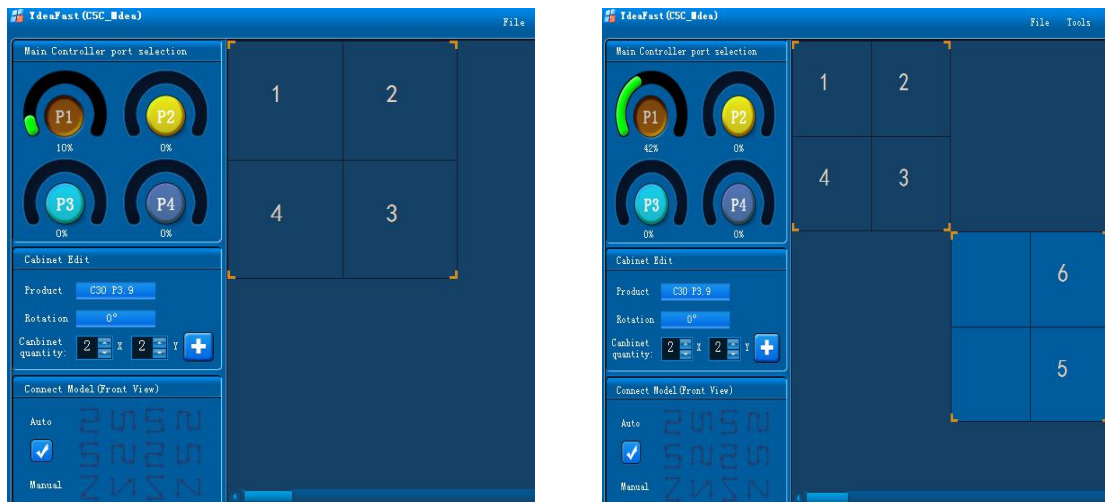

(Picture 22 wire connection window) (Picture 23 wire connection window)

When finish setting, clicking the window, which is set up already. Then click the right mouse button will get the setting as below:

Delete window: can clear the chosen windows

Clear window: can clear all the windows on the port of the main controller

Clear wire connection: can clear all the wires at the port of the controller

Gluing : when the adding window is near the existed window, software will glue them automatically. When cancel the gluing, the

<http://www.ydeachn.com/>

Address: Skyworth innovation valley 5# A layer ,901 Tangtou Road no. 1 on the 8th Shiyan Street Baoan District Shenzhen City .

adding windows can be placed randomly.

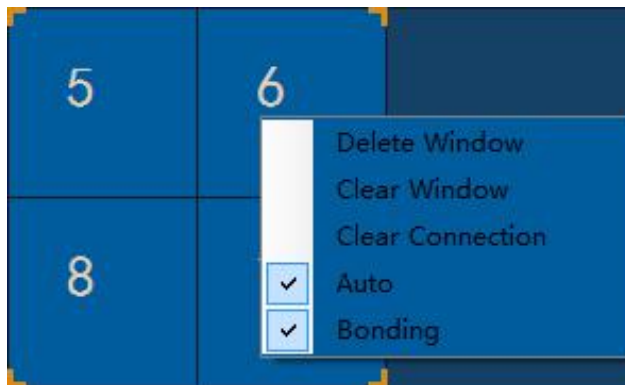

(Picture 24 wire connection window)

4.1 Send parameter

Finish setting, clicking sending at the bottom right corner

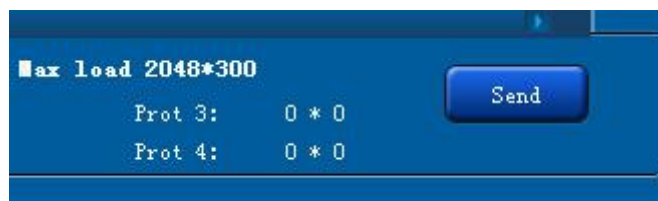

(Picture 25 sending)

C5M_Mdea system software operation

<http://www.ydeachn.com/>

Address: Skyworth innovation valley 5# A layer ,901 Tangtou Road no. 1 on the 8th Shiyan Street
Baoan District Shenzhen City .

1. Screen connection

1.1 Main controller port selection



(picture 26 main controller port)

Remark:

1.Mdea system supports single port output. Set P1 in the software.

Single port can support max pixels of 1024*600.

2.The default port in the software is P1.

1.2 Port adding

click "Port Pattern" to enter subsidiary interface



(picture27 port adding)

<http://www.ydeachn.com/>

Address:Skyworth innovation valley 5# A layer ,901 Tangtou Road no. 1 on the 8th Shiyan Street
Baoan District Shenzhen City .

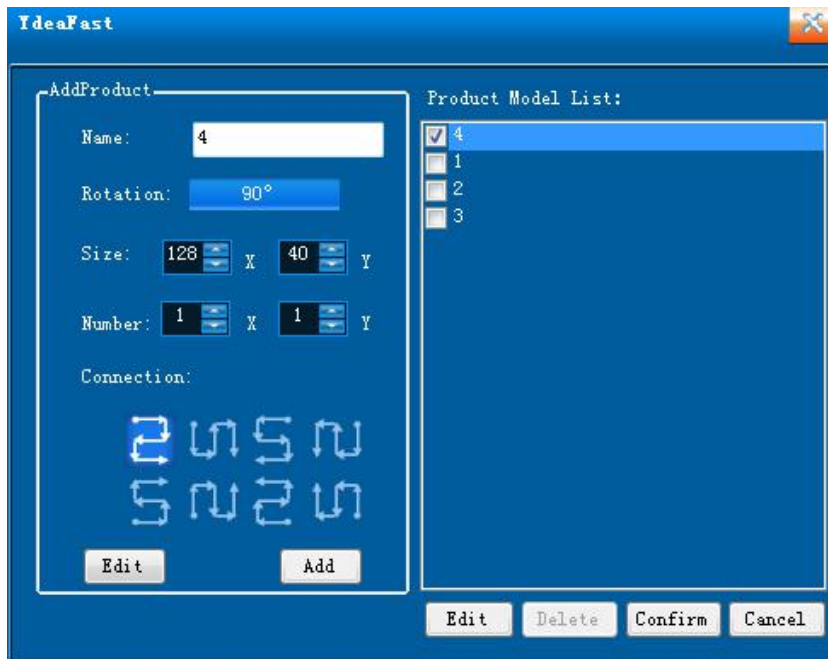

(picture 28 adding)

Name: set the name according your requirement.

Rotation: 0°,90°,180°,270° four direction rotation, which is anticlockwise.

Remark: this function need receiving card procedure support.

Size: single screen's width (X) and height (Y)

Remark: size here means: single Micro receiving card's loading pixels

Quantity: horizontal screen quantity (X) and vertical screen quantity (Y).

Remarks: Quantity means the receiving card amount of single port from the distributor.

Wire connection mode: set the inner wire take-up way of the port.

There are 8 kinds of wire connection modes. If the wire connection mode is irregular, click <edit> to enter complicated mode setting

<http://www.ydeachn.com/>

Address: Skyworth innovation valley 5# A layer ,901 Tangtou Road no. 1 on the 8th Shiyan Street
Baoan District Shenzhen City .

Remarks: wire connection mode: means the receiving card connection mode of single port from distributor.

Adding: after setting parameter, click [adding] to produce ports.

Remarks:

1.In this option, according to the screen size and the quantity, system will automatically select relevant distributor mode. Support modes of 32*1200、 64*960 、 128*480 、 256*240 、 512*120 、 1024*60. That means, the distributors will be automatically matched with the corresponding mode of the same loading pixels.

2.If rotation needed , first need to fill in the name, size of cabinet (default direction depends on the size of the screen), quantity (after rotation, the actual loading quantity at X direction and the quantity of Y direction). Selecting wire connection mode, and rotation angle, then click add, the size of the cabinet will be automatically changed according to the advanced chosen rotation angle.

For example:

the screen of defaulted angle, size is 96*16. The power is at the right.

If vertical placing is need, the power box should be placed at the top, with 5 panels installed. Then fill in the name and the single module size is X96, Y16, quantity of X5, Y1. Select the wire connection mode,

<http://www.ydeachn.com/>

Address:Skyworth innovation valley 5# A layer ,901 Tangtou Road no. 1 on the 8th Shiyan Street
Baoan District Shenzhen City .

and the rotation angle is 270°.

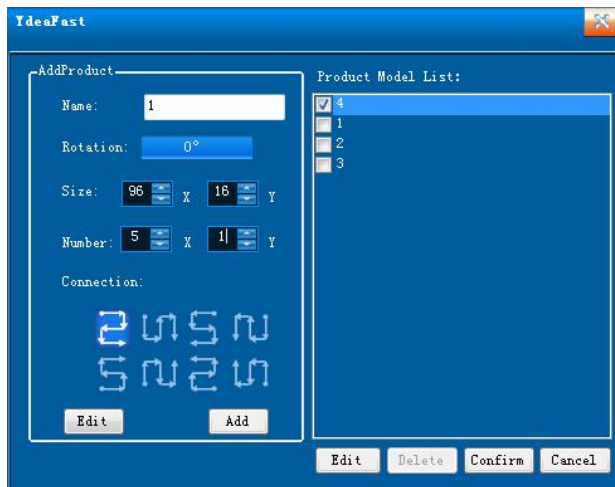

(picture 29 Pattern adding)

Finally click adding, then the single screen will change to be X16, Y96. But the quantity will keep the same. That means, rotation angle will only select the size of the single screen, other than rotation quantity.

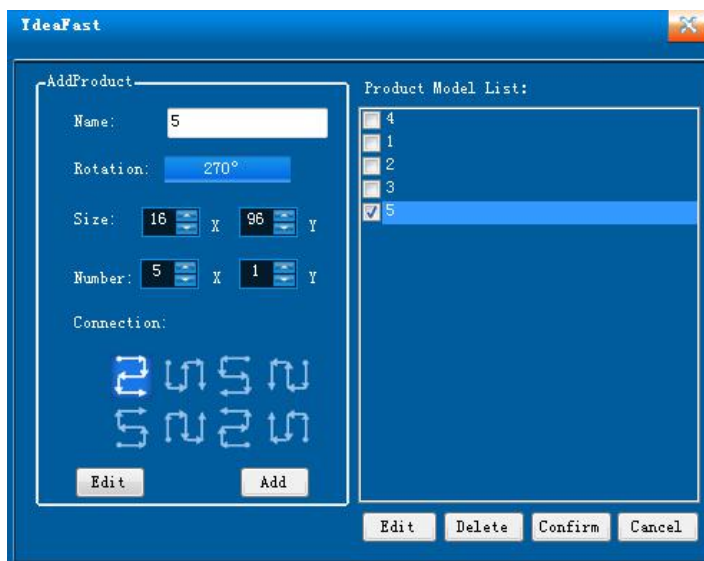

(picture 30 Pattern adding)

<http://www.ydeachn.com/>

Address: Skyworth innovation valley 5# A layer ,901 Tangtou Road no. 1 on the 8th Shiyan Street
Baoan District Shenzhen City .

Complicated mode

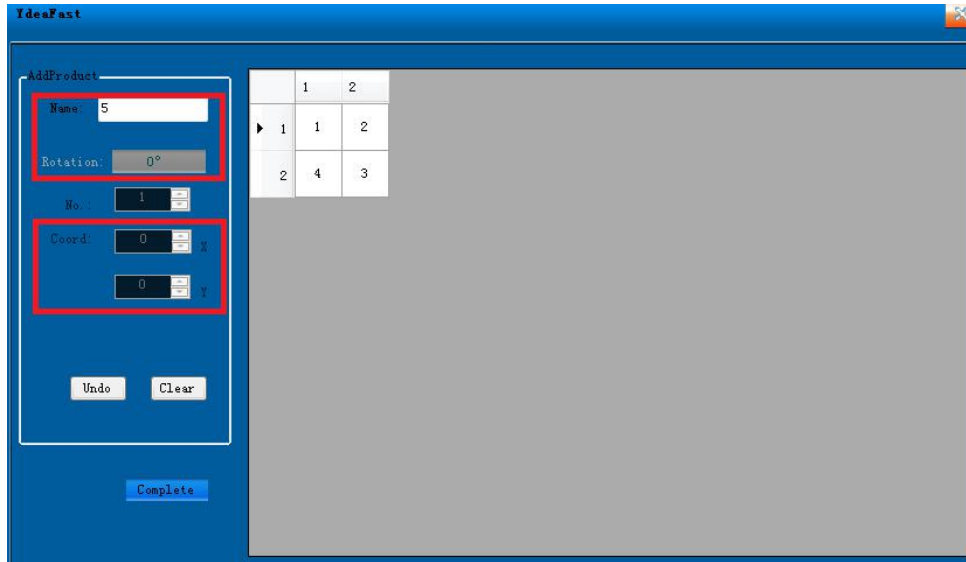

(picture 31port mode edit)

Click <edit> to enter complicated mode setting

Name: set the name to make distinction

Rotation: four directions rotation. Can realize single cabinet rotation.

Sequence number: mapping the sequence at the right of window, that is receiving card physical address with default value of 1.

Coordinate: can change the original initial coordinate to show different position;

Cancel and clear: it is convenient to modify signal wire take-up way;

Finish: finish setting and click confirm;

<http://www.ydeachn.com/>

Address: Skyworth innovation valley 5# A layer ,901 Tangtou Road no. 1 on the 8th Shiyan Street
Baoan District Shenzhen City .

1.3 Port quantity



(picture32 port setting)

Set the quantity of port: one window represents one output of distributor. If there are two or more than two distributors cascading together, and more than 8 windows in one port of controller, it will step automatically to next distributor. After setting quantity, click "+", then click the left mouse button to add windows at the right of the vacant area.

Remarks :

1. the port quantity refers to the arrange of the output of distributor.
2. The output of distributor can be arranged randomly.

1.4 Position accurate adjustment

Windows can be moved randomly within the pixels of the loading. Vacant area is like the screen of computer. Via the accurate adjustment of the position at the bottom left corner to set the original coordinate.

Remark :

Via adding single port to realize modifying every distributor output original coordinate separately. Shown as below: 1~8 represent first

<http://www.ydeachn.com/>

Address: Skyworth innovation valley 5# A layer ,901 Tangtou Road no. 1 on the 8th Shiyan Street
Baoan District Shenzhen City .

distributor's 8 outputs. 9~16 represent second distributor's 8 outputs. These two distributors are cascaded, which are loaded by Mdea port.



(picture33 connection window)

1.5 Wire connection mode(facing the screen)

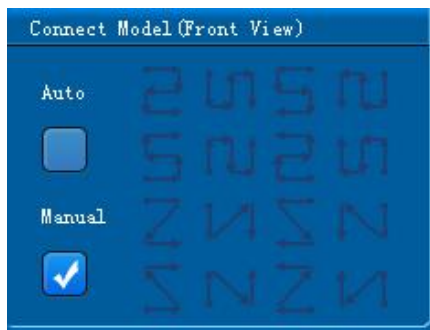

(picture34 wire connection mode)

Wire connection mode means the wire take-up way at the back of the screen. There are manual and automatic selection. When choosing automatic one, there are 8 ways to be selected; when choose manual one, you can click on the window to arrange the cable, which can realize the

<http://www.ydeachn.com/>

Address: Skyworth innovation valley 5# A layer ,901 Tangtou Road no. 1 on the 8th Shiyan Street
Baoan District Shenzhen City .

irregular wire arrangement. Any place without wire has to keep vacant.

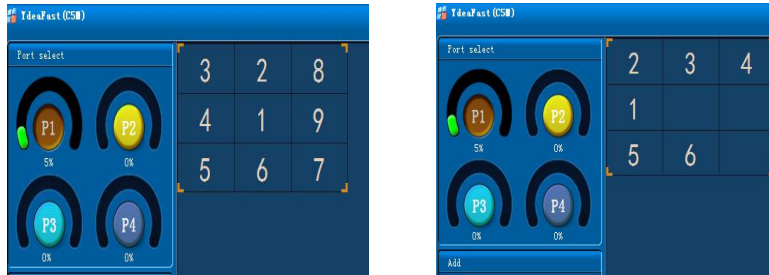

(picture 35 wire connection window)

Select the windows, which have been set. Then click the right mouse button to get the setting as below:

Delete window: can clear the chosen windows

Clear window: can clear all the windows on the port of the main controller ;

Clear wire connection: can clear all the wires at the port of the controller

Gluing : when the adding window is near the existed window, software will glue them automatically. When cancel the gluing, the adding windows can be placed randomly.

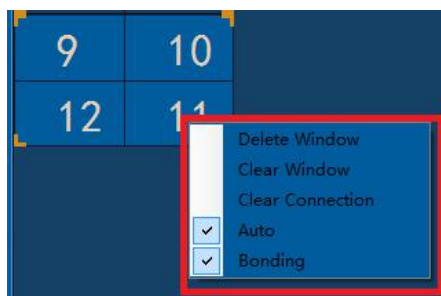

(picture36 connection window)

1.6 Send parameter

Click send after setting

<http://www.ydeachn.com/>

Address: Skyworth innovation valley 5# A layer ,901 Tangtou Road no. 1 on the 8th Shiyan Street
Baoan District Shenzhen City .



(picture 37 connection)

MDEA2PLUS system Q&A introduction

Questions	adjust and solutions
PW indicator light is on, and WK is not flickering	1 WK light flicker means Mdea works normally. 2 PH light flickers means network signal transfers to the receiving card normally
Fail to send parameter	Check whether computer is connected to Mdea
Color is not clear	Make sure the gray level is sent correctly.
signal is normal, and screen is black.	Check whether the brightness is zero. 2. make sure the on/off status is on 
Mdea connect is not	Check whether Mdea hot state under normal, PC wireless networks Whether the connection this hot spot

MDEA2PLUS system installation size

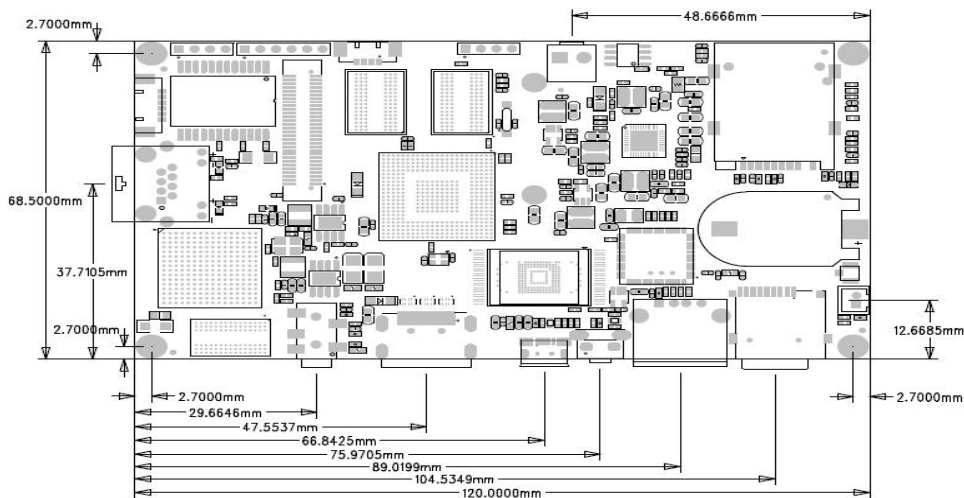

<http://www.ydeachn.com/>

Address: Skyworth innovation valley 5# A layer ,901 Tangtou Road no. 1 on the 8th Shiyan Street
Baoan District Shenzhen City .