

XMOZU 1X3 Fixed Installation Bracket

Specification

Self R&D for light,slim,low cost led display fixed installation. Applied on banner screen and building big screen.

■ Packing items

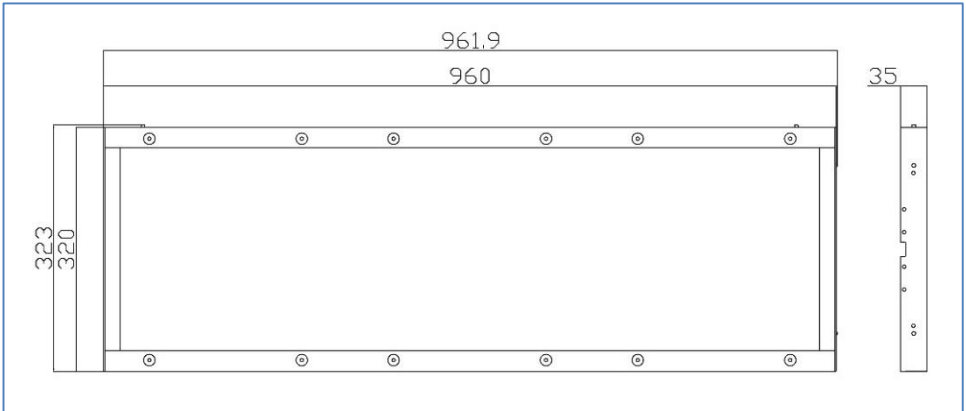

1. 1X3 fixed installation bracket



2. 304 stainless steel self-tapping screw

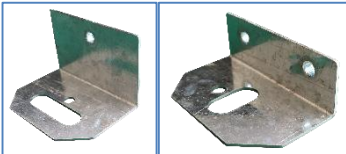

3. "L"Connector

■ Bracket Parameter

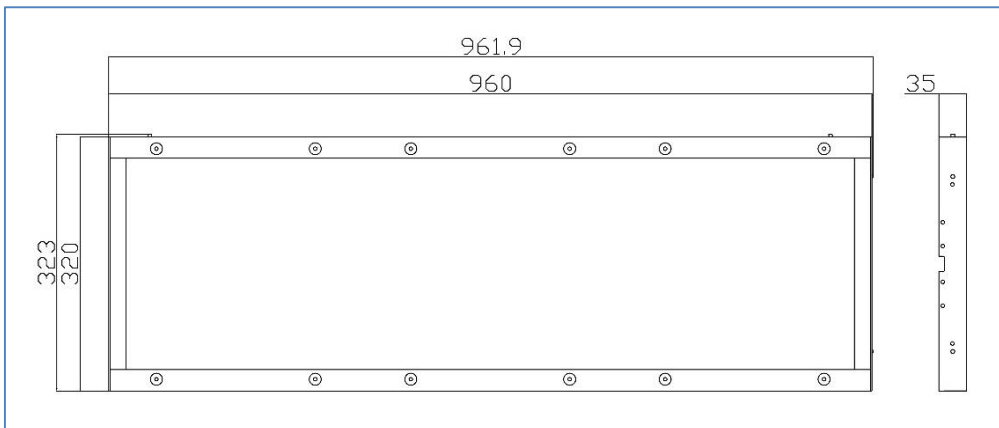

1.Bracket Size mm: 960(length)*320(width)*35(height)

2.Weight KG: 1.53

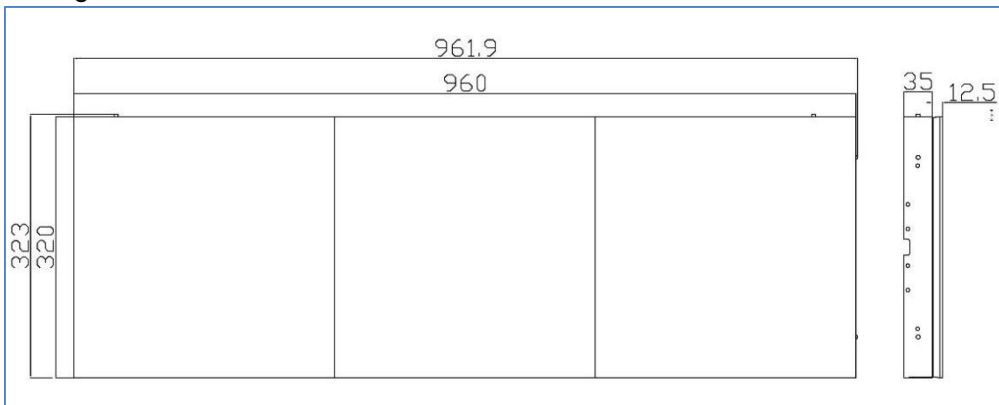

3.Finished XMOZU screen size mm:

961.9(Length)*323(Width)*47.5(Height)

■ Installation

1. Single bracket installation

1). Position: Align 2 brackets by side location column

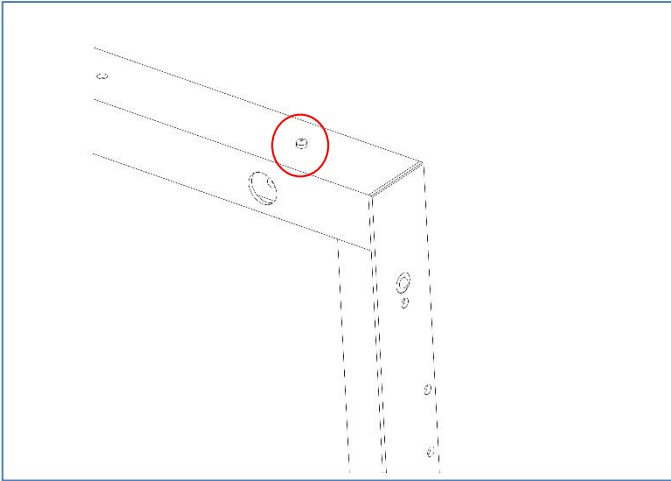

2). Fixing: fix bracket on wall with screw

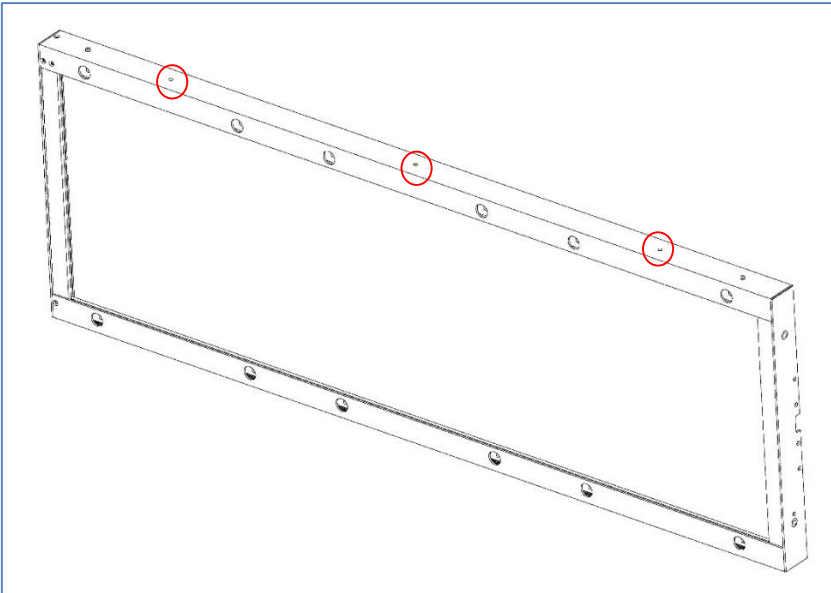

2.Screen Installation

1). Embed XMOZU panel position column into bracket hole,tap screen to ensure connect.

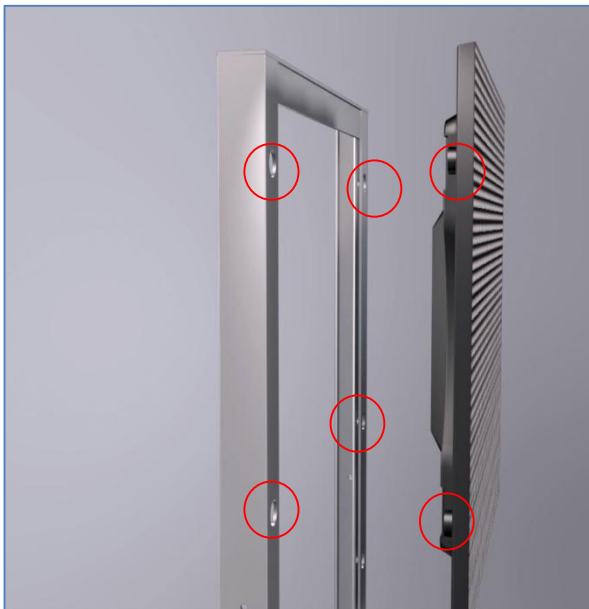

2). Fit screen and bracket fasten together with screw.



3.Fix bracket on wall

1). Fit “L” connector on bracket (on side)

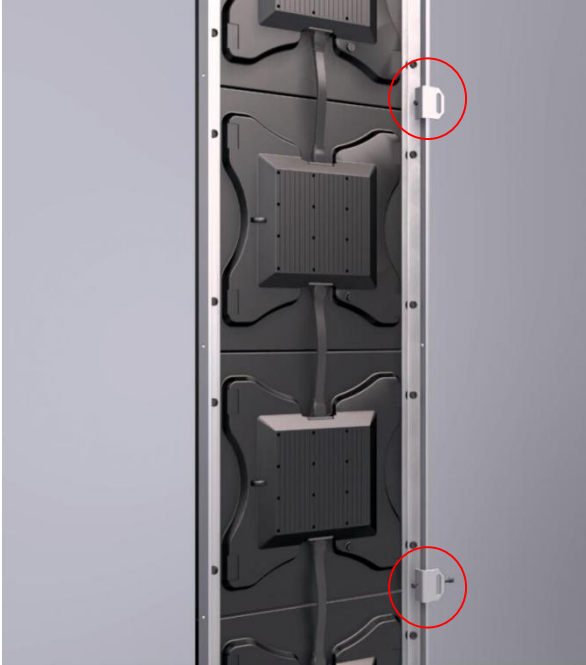

2). Fit “L” connector on bracket (top and bottom side)

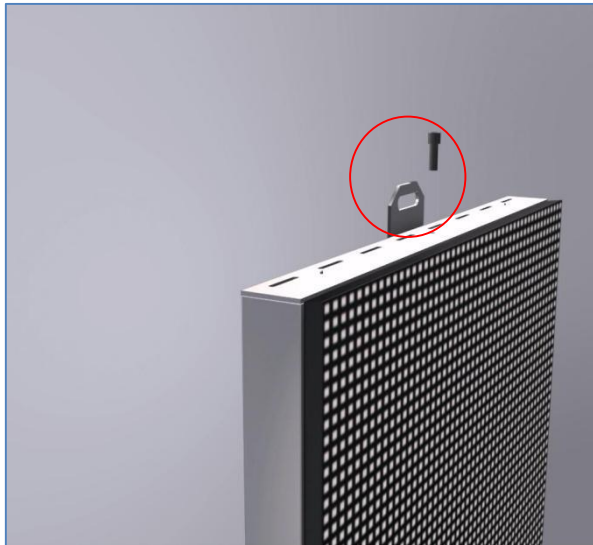

3). Fix “L” connector in order on wall with screw.

